

# HCW65D30D1QA

## eSiC Automotive Silicon Carbide Schottky Diode

650V, 30A

### Description

The 650V eSiC is an advanced Power Master Semiconductor's silicon carbide diode family.

This technology combines the benefits of excellent low capacitive charge and robustness.

Consequently, the eSiC family is suitable for application requiring high power efficiency.

### Applications

- OBC (On Board Charger)
- DC/DC Converter for EV/HEV
- Wireless Charger

### Features

$V_{RRM}$	$I_F$	$T_{J,max}$	$Q_C$
650 V	16 / 30 A	175 °C	48 nC

- No reverse recovery current
- Low forward voltage
- 175°C Max junction temperature
- High surge current capability
- Switching behavior independent of temperature
- AEC Q101 Qualified
- Pb-Free, Halogen Free and RoHS compliant

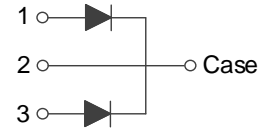
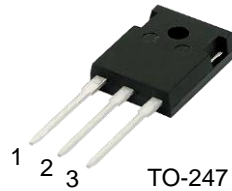

### Absolute Maximum Ratings (Per Leg / Device & Per Leg, $T_C = 25^\circ\text{C}$ unless otherwise noted)

Symbol	Parameter	Value	Unit
$V_{RRM}$	Repetitive Peak Reverse Voltage	650	V
$I_F$	Forward Current	$T_C=123^\circ\text{C}$ 16 / 30	A
$I_{F,SM}$	Non-Repetitive Forward Surge Current	$T_C=25^\circ\text{C}$ , $t_p=10$ ms	73
		$T_C=150^\circ\text{C}$ , $t_p=10$ ms	62.1
$I_{F,Max}$	Non-Repetitive Peak Forward Current	$T_C=25^\circ\text{C}$ , $t_p=10$ us	690
		$T_C=150^\circ\text{C}$ , $t_p=10$ us	587
$I^2dt$ value	$\int I^2t$	$T_C=25^\circ\text{C}$ , $t_p=10$ ms	26.6
		$T_C=150^\circ\text{C}$ , $t_p=10$ ms	19.2
$P_{tot}$	Power Dissipation	$T_C=25^\circ\text{C}$ 94	W
$T_J, T_{STG}$	Operating Junction and Storage Temperature	-55 to +175	$^\circ\text{C}$

### Thermal Characteristics

Symbol	Parameter	Value	Unit
$R_{\theta JC}$	Thermal Resistance, Junction to Case, Max.(Per Leg / Per Device)	1.6 / 0.8	$^\circ\text{C/W}$

**Package Marking and Ordering Information**

Part Number	Top Marking	Package	Packing Method	Quantity
HCW65D30D1QA	HCW65D30D1QA	TO-247	Tube	30 units

**Electrical Characteristics** (Per Leg,  $T_C = 25^\circ\text{C}$  unless otherwise noted)

Symbol	Parameter	Test Conditions	Min	Typ	Max	Unit
$V_F$	Forward Voltage	$I_F=16\text{ A}, T_C=25^\circ\text{C}$		1.40	1.7	V
		$I_F=16\text{ A}, T_C=175^\circ\text{C}$		1.55	-	
$I_R$	Reverse Current	$V_R=650\text{ V}, T_C=25^\circ\text{C}$		-	100	$\mu\text{A}$
		$V_R=650\text{ V}, T_C=175^\circ\text{C}$		-	300	
$Q_C$	Total Capacitive Charge	$V_R=400\text{ V}, T_C=25^\circ\text{C}$		48		nC
C	Total Capacitance	$V_R=1\text{ V}, f=100\text{ kHz}$		751		pF
		$V_R=400\text{ V}, f=100\text{ kHz}$		75		
$E_C$	Capacitance Stored Energy	$V_R=400\text{ V}, T_C=25^\circ\text{C}$		7.1		$\mu\text{J}$

Typical Performance Characteristics (Per Leg)

Figure 1. Power Derating

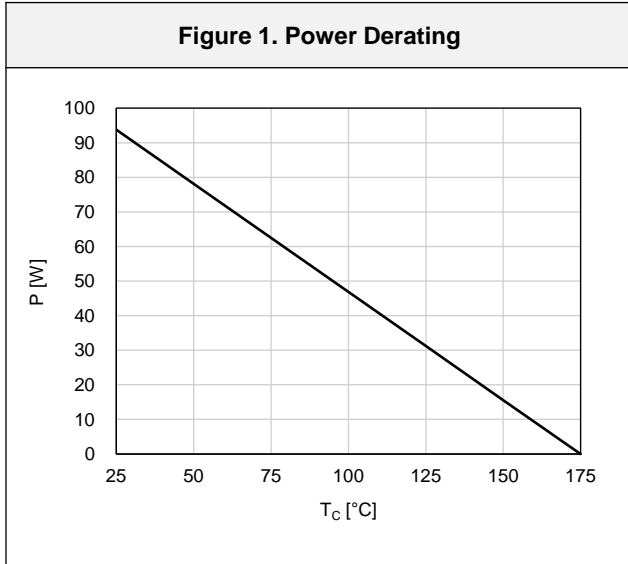

Figure 2. Current Derating

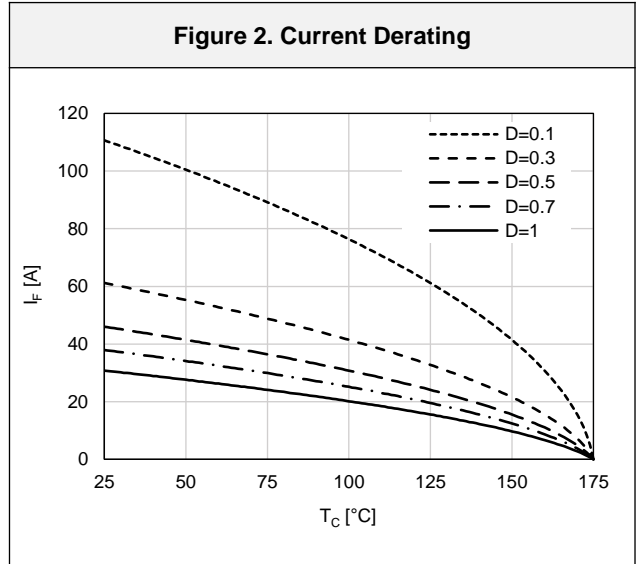

Figure 3. Forward Characteristics

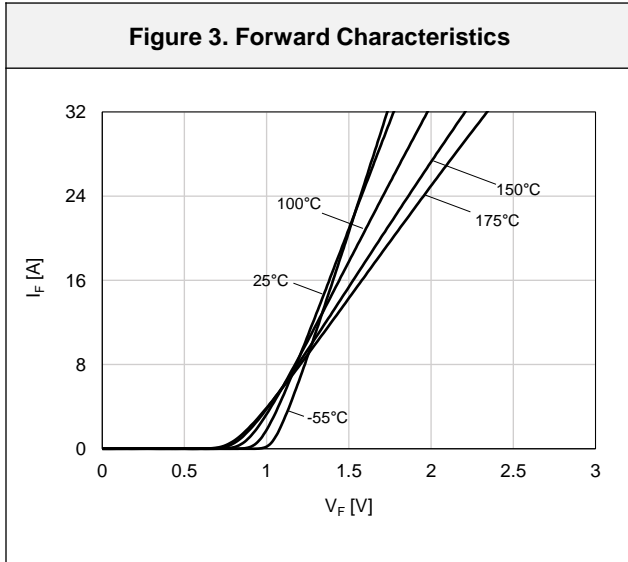

Figure 4. Reverse Characteristics

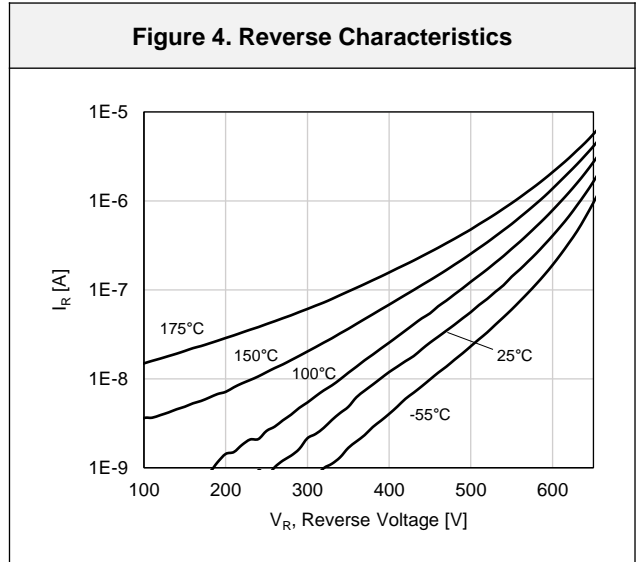

Figure 5. Capacitive Charge Characteristic

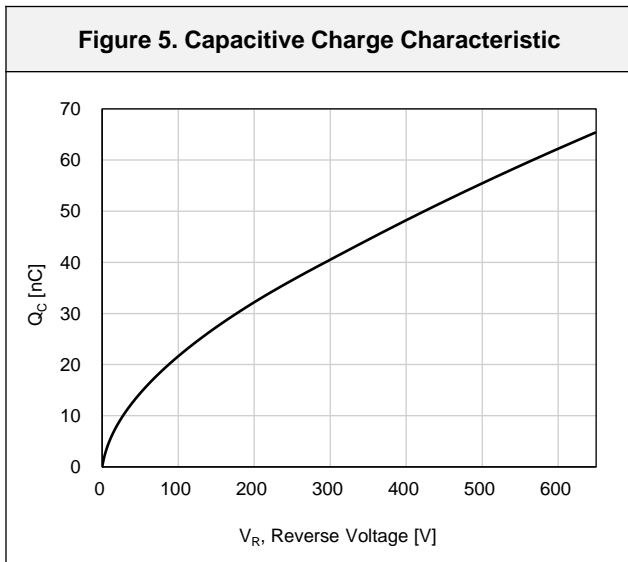
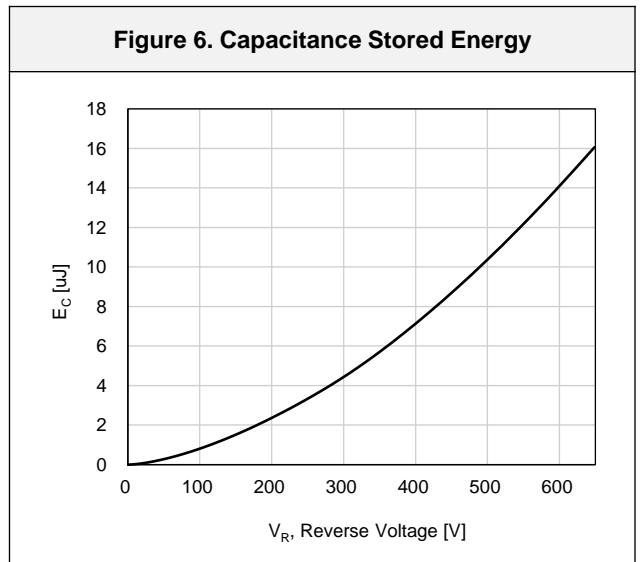

Figure 6. Capacitance Stored Energy



Typical Performance Characteristics (Per Leg)

Figure 7. Capacitance Characteristic

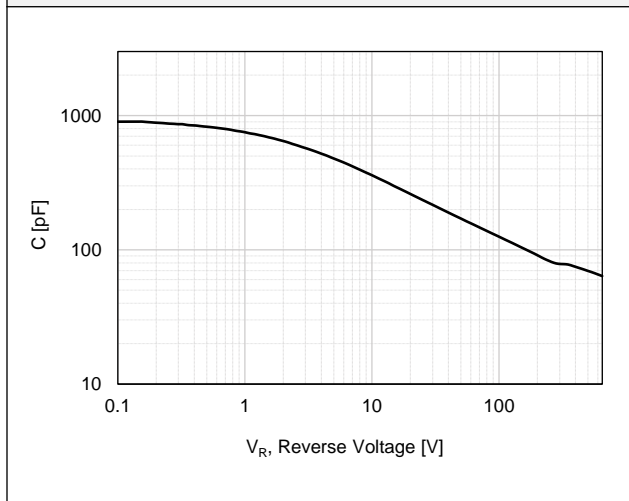
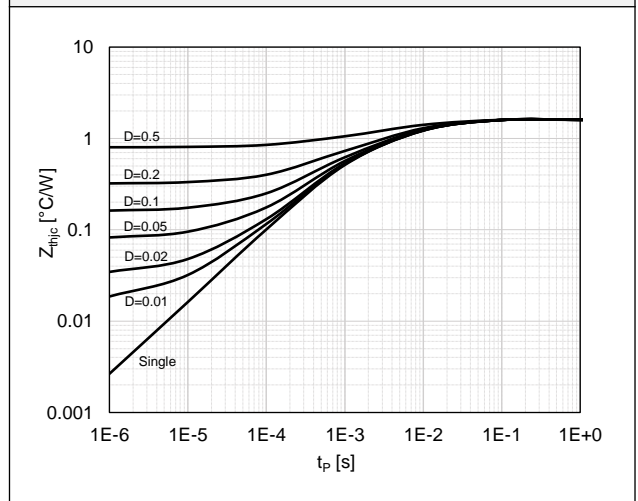
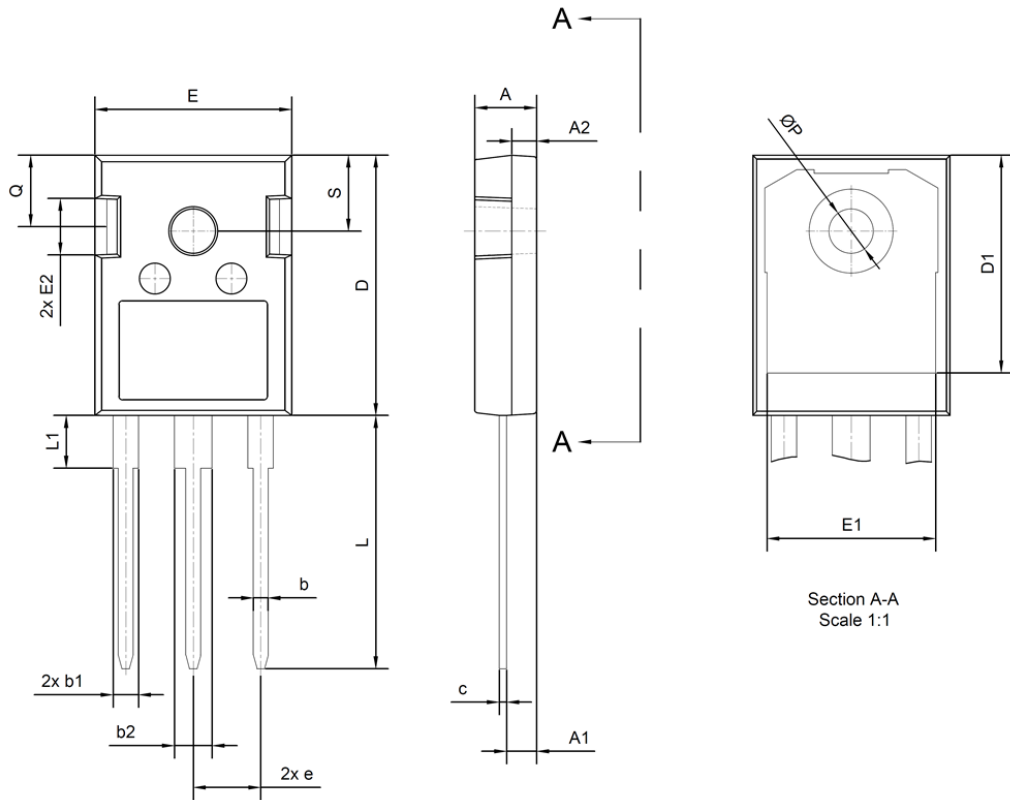

Figure 8. Transient Thermal Response Curve



Package Outlines

TO-247



Section A-A  
Scale 1:1

SYMBOL	Common		
	DIMENSIONS MILLIMETER		
	MIN.	NOM.	MAX.
A	4.80	5.00	5.20
A1	2.29	2.42	2.54
A2	1.90	2.00	2.10
b	1.10	1.20	1.30
b1	1.91	2.06	2.20
b2	2.92	3.06	3.20
c	0.50	0.60	0.70
D	20.80	21.07	21.34
D1	17.23	17.63	18.03
E	15.75	15.94	16.13
E1	13.46	13.66	13.86
E2	4.32	4.58	4.83
e	5.46 BSC		
L	19.85	20.05	20.25
L1	4.05	4.27	4.48
ØP	3.56	3.61	3.66
Q	5.38	5.79	6.20
S	6.15 BSC		