

HCW120D30D1A

eSiC Automotive Silicon Carbide Schottky Diode

1200V, 30A

Description

The 1200V eSiC is an advanced Power Master Semiconductor's silicon carbide diode family. This technology combines the benefits of excellent low forward voltage and robustness. Consequently, the eSiC family is suitable for application requiring high power efficiency

Applications

- OBC (On Board Charger)
- DC/DC Converter for EV/HEV
- Wireless Charger

Features (Per Leg/Device)

V_{RRM}	I_F	$T_{J,max}$	Q_C
1200 V	15 / 30 A	175 °C	92 nC

- No reverse recovery current
- Low forward voltage
- 175°C Max junction temperature
- High surge current capability
- Switching behavior independent of temperature
- AEC Q101 Qualified
- Pb-Free, Halogen Free and RoHS compliant

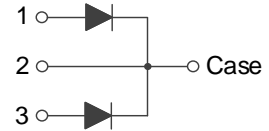
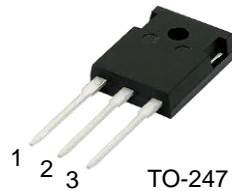

Absolute Maximum Ratings (Per Leg / Device, Per Leg unless otherwise specified)

Symbol	Parameter	Value	Unit	
V_{RRM}	Repetitive Peak Reverse Voltage	$T_C = 25^\circ\text{C}$ 1200	V	
I_F	Forward Current	$T_C = 147^\circ\text{C}$ 15 / 30	A	
$I_{F,SM}$	Non-Repetitive Forward Surge Current	$T_C = 25^\circ\text{C}, t_p = 10 \text{ ms}$	106	A
		$T_C = 150^\circ\text{C}, t_p = 10 \text{ ms}$	90	A
$I_{F,Max}$	Non-Repetitive Peak Forward Current	$T_C = 25^\circ\text{C}, t_p = 10 \mu\text{s}$	850	A
		$T_C = 150^\circ\text{C}, t_p = 10 \mu\text{s}$	722	A
I^2dt value	$\int I^2t$	$T_C = 25^\circ\text{C}, t_p = 10 \text{ ms}$	56	A ² s
		$T_C = 150^\circ\text{C}, t_p = 10 \text{ ms}$	40	A ² s
P_{tot}	Power Dissipation	$T_C = 25^\circ\text{C}$ 183	W	
T_J, T_{STG}	Operating Junction and Storage Temperature	-55 to +175	°C	

Thermal Characteristics

Symbol	Parameter	Value	Unit
$R_{\theta JC}$	Thermal Resistance, Junction to Case, Max. (Per Leg / Device)	0.82/0.4	°C/W

Package Marking and Ordering Information

Part Number	Top Marking	Package	Packing Method	Quantity
HCW120D30D1A	HCW120D30D1A	TO-247	Tube	30 units

Electrical Characteristics (Per Leg, $T_C = 25^\circ\text{C}$ unless otherwise noted)

Symbol	Parameter	Test Conditions	Min	Typ	Max	Unit
V_F	Forward Voltage	$I_F = 15\text{ A}, T_C = 25^\circ\text{C}$		1.39	1.70	V
		$I_F = 15\text{ A}, T_C = 175^\circ\text{C}$		1.8	-	
I_R	Reverse Current	$V_R = 1200\text{ V}, T_C = 25^\circ\text{C}$		-	100	μA
		$V_R = 1200\text{ V}, T_C = 175^\circ\text{C}$		-	300	
Q_C	Total Capacitive Charge	$V_R = 800\text{ V}, T_C = 25^\circ\text{C}$		92		nC
C	Total Capacitance	$V_R = 1\text{ V}, f = 100\text{ kHz}$		1010		pF
		$V_R = 800\text{ V}, f = 100\text{ kHz}$		65		
E_C	Capacitance Stored Energy	$V_R = 800\text{ V}, T_C = 25^\circ\text{C}$		26		μJ

Typical Performance Characteristics (Per Leg)

Figure 1. Power Derating

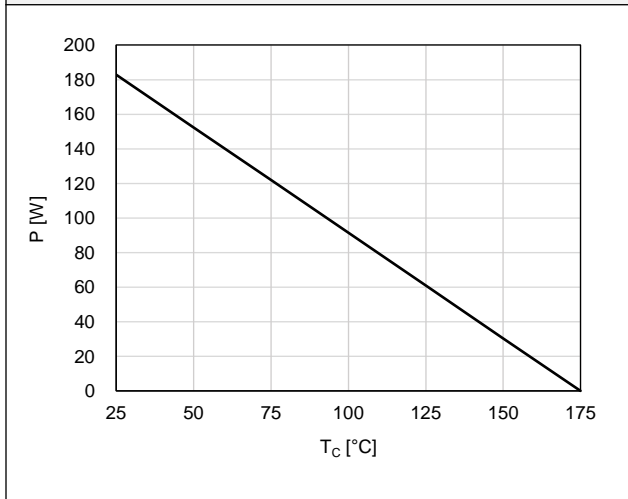

Figure 2. Current Derating

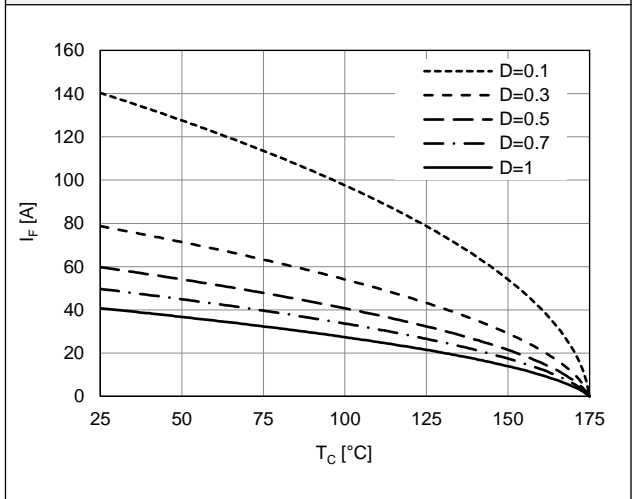

Figure 3. Forward Characteristics

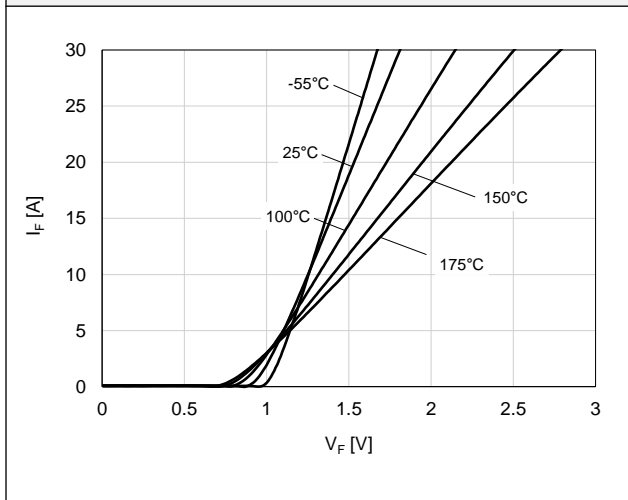

Figure 4. Reverse Characteristics

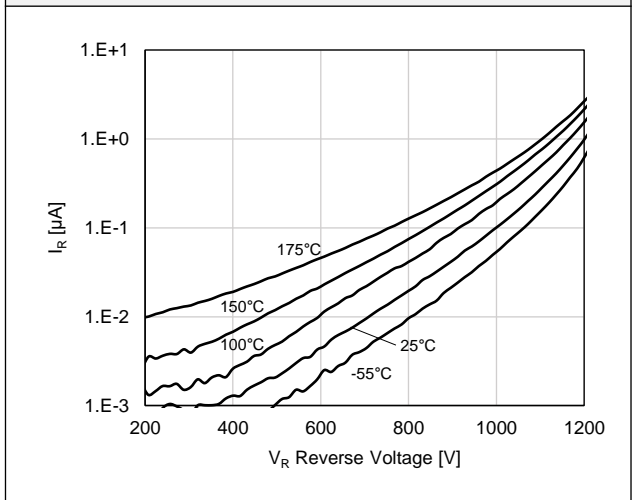

Figure 5. Capacitive Charge Characteristics

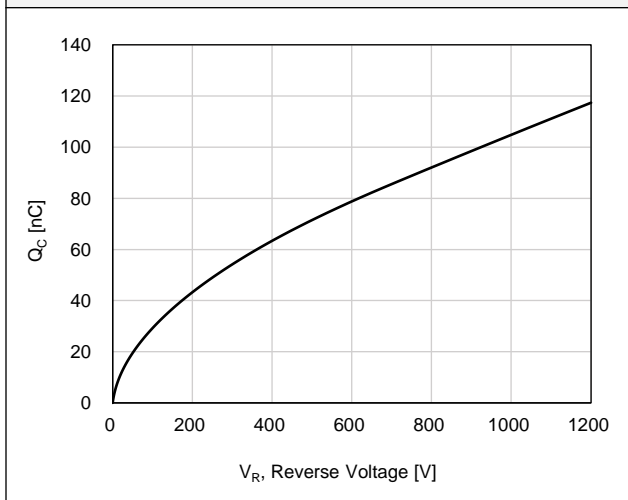
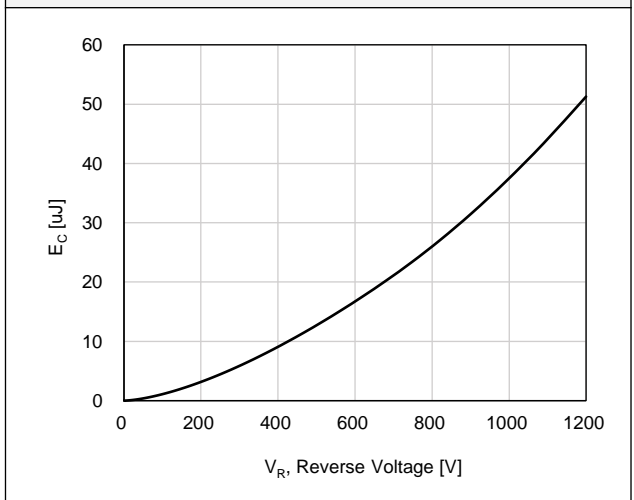

Figure 6. Capacitance Stored Energy



Typical Performance Characteristics (Per Leg)

Figure 7. Capacitance Characteristics

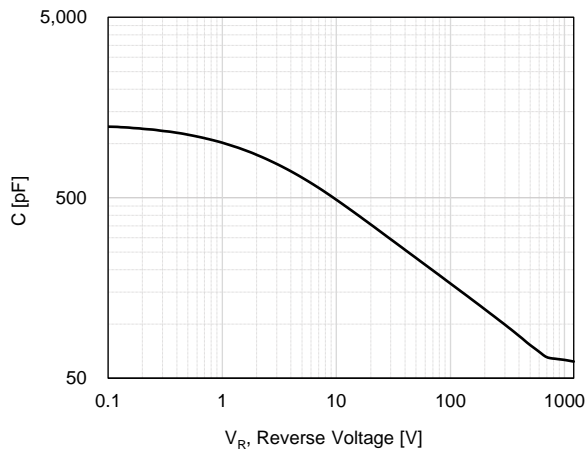
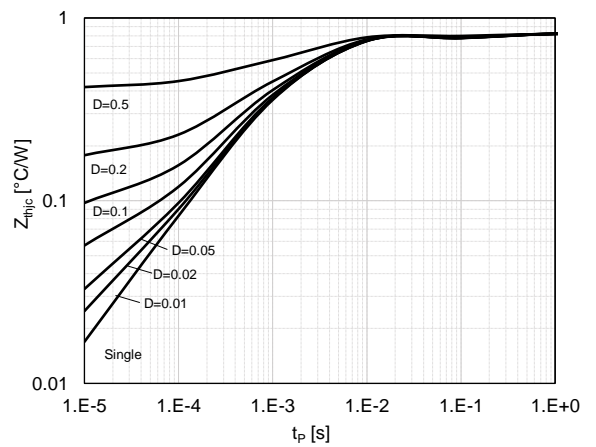
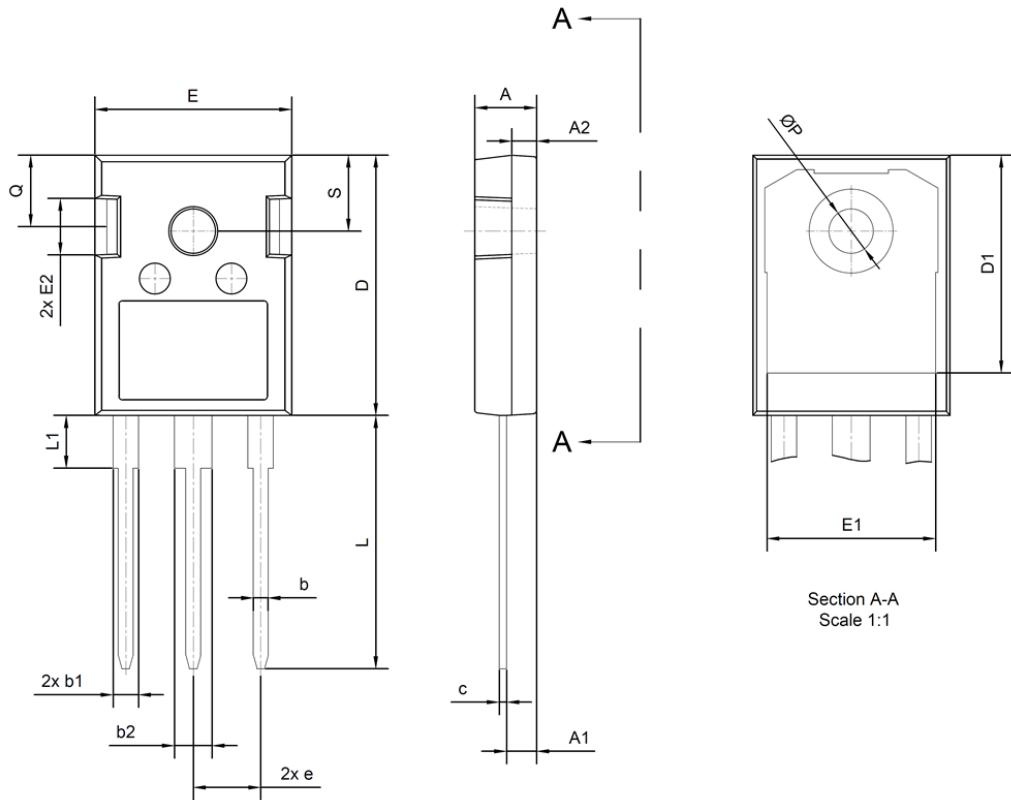

Figure 8. Transient Thermal Response Curve



Package Outlines

TO-247



Section A-A
Scale 1:1

SYMBOL	Common		
	DIMENSIONS MILLIMETER		
	MIN.	NOM.	MAX.
A	4.80	5.00	5.20
A1	2.29	2.42	2.54
A2	1.90	2.00	2.10
b	1.10	1.20	1.30
b1	1.91	2.06	2.20
b2	2.92	3.06	3.20
c	0.50	0.60	0.70
D	20.80	21.07	21.34
D1	17.23	17.63	18.03
E	15.75	15.94	16.13
E1	13.46	13.66	13.86
E2	4.32	4.58	4.83
e	5.46 BSC		
L	19.85	20.05	20.25
L1	4.05	4.27	4.48
ØP	3.56	3.61	3.66
Q	5.38	5.79	6.20
S	6.15 BSC		