

HCH120S10D1

eSiC Silicon Carbide Schottky Diode

1200V, 10A

Description

The 1200V eSiC is an advanced Power Master Semiconductor's silicon carbide diode family.

This technology combines the benefits of excellent low forward voltage and robustness.

Consequently, the eSiC family is suitable for application requiring high power efficiency

Applications

- Solar inverter, UPS
- EV charging station
- Power Factor Correction

Features

V_{RRM}	I_F	$T_{J,max}$	Q_C
1200 V	10 A	175 °C	63 nC

- No reverse recovery current
- Low forward voltage
- 175°C Max junction temperature
- High surge current capability
- Switching behavior independent of temperature
- Pb-Free, Halogen Free and RoHS compliant

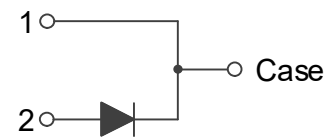
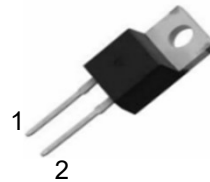

Absolute Maximum Ratings ($T_C = 25^\circ\text{C}$ unless otherwise noted)

Symbol	Parameter	Value	Unit
V_{RRM}	Repetitive Peak Reverse Voltage	1200	V
I_F	Forward Current	$T_C=154^\circ\text{C}$ 10	A
$I_{F,SM}$	Non-Repetitive Forward Surge Current	$T_C=25^\circ\text{C}, t_p=10\text{ms}$	79
		$T_C=150^\circ\text{C}, t_p=10\text{ms}$	67
$I_{F,Max}$	Non-Repetitive Peak Forward Current	$T_C=25^\circ\text{C}, t_p=10\mu\text{s}$	810
		$T_C=150^\circ\text{C}, t_p=10\mu\text{s}$	690
I^2dt value	$\int i^2 dt$	$T_C=25^\circ\text{C}, t_p=10\text{ms}$	31
		$T_C=150^\circ\text{C}, t_p=10\text{ms}$	23
P_{tot}	Power Dissipation	$T_C=25^\circ\text{C}$ 167	W
T_J, T_{STG}	Operating Junction and Storage Temperature	-55 to +175	°C

Thermal Characteristics

Symbol	Parameter	Value	Unit
$R_{\theta JC}$	Thermal Resistance, Junction to Case, Max.	0.90	°C/W

Package Marking and Ordering Information

Part Number	Top Marking	Package	Packing Method	Quantity
HCH120S10D1	HCH120S10D1	TO-220	Tube	50 units

Electrical Characteristics (T_C = 25°C unless otherwise noted)

Symbol	Parameter	Test Conditions	Min	Typ	Max	Unit
V _F	Forward Voltage	I _F =10A, T _C =25°C		1.39	1.70	V
		I _F =10A, T _C =175°C		1.8	-	
I _R	Reverse Current	V _R =1200V, T _C =25°C		-	100	μA
		V _R =1200V, T _C =175°C		-	300	
Q _C	Total Capacitive Charge	V _R =800V, T _C =25°C		63		nC
C	Total Capacitance	V _R =1V, f=100Khz		696		pF
		V _R =800V, f=100Khz		44		
E _C	Capacitance Stored Energy	V _R =800V, T _C =25°C		18		μJ

Typical Performance Characteristics

Figure 1. Power Derating

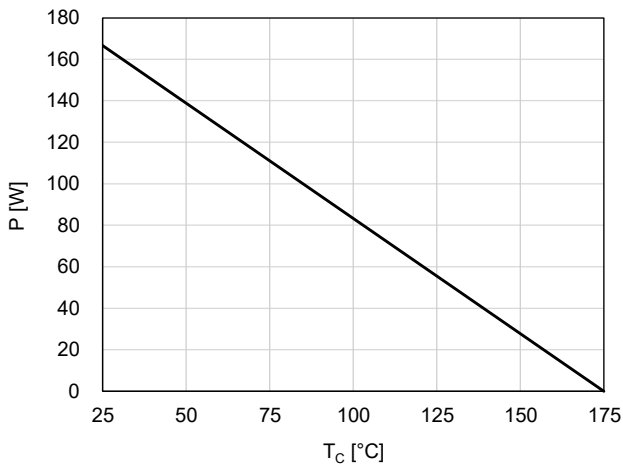

Figure 2. Current Derating

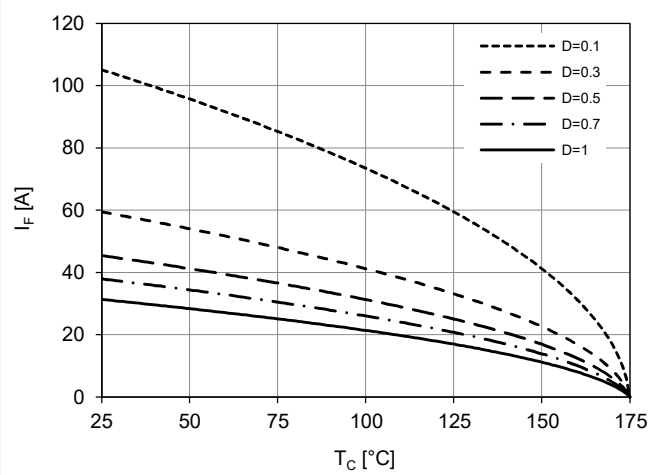

Figure 3. Forward Characteristics

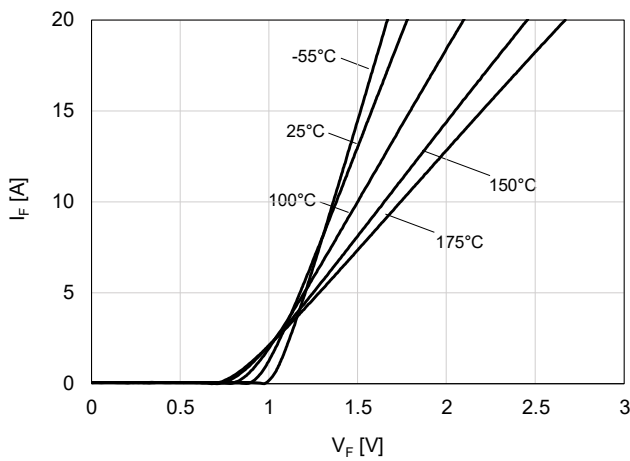

Figure 4. Reverse Characteristics

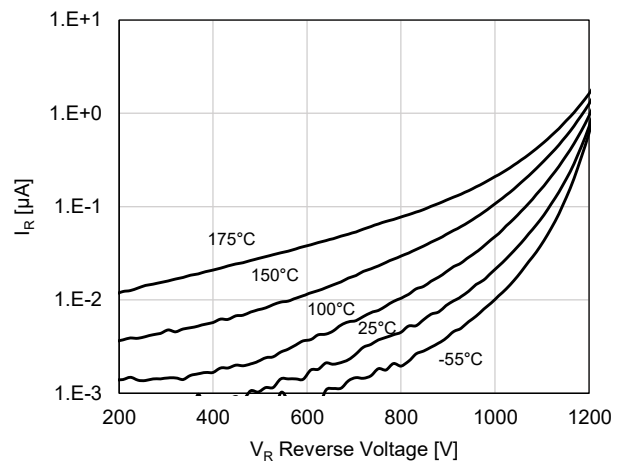

Figure 5. Capacitive Charge Characteristic

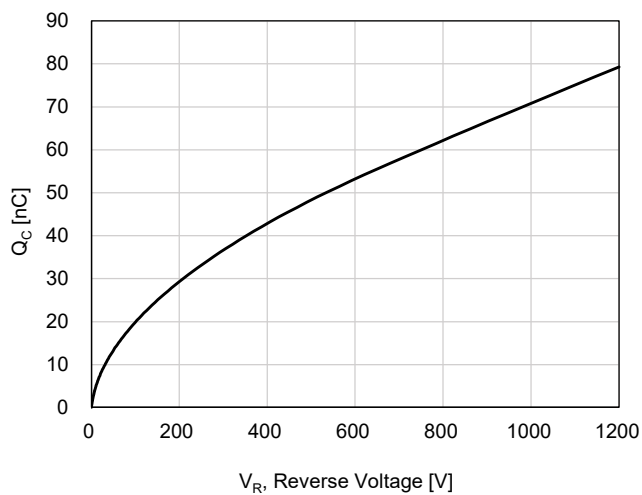
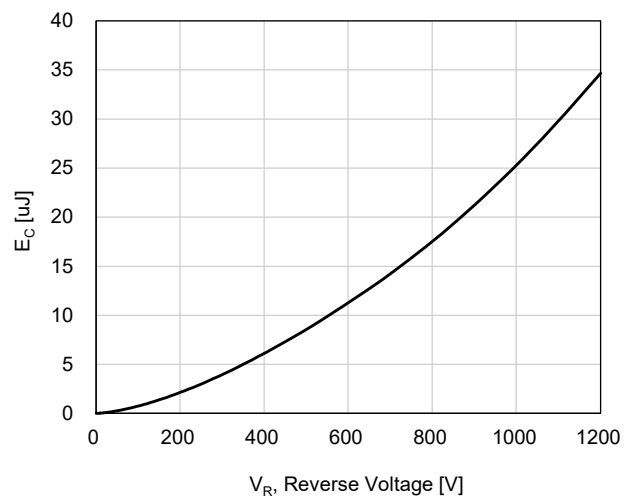

Figure 6. Capacitance Stored Energy



Typical Performance Characteristics

Figure 7. Capacitance Characteristic

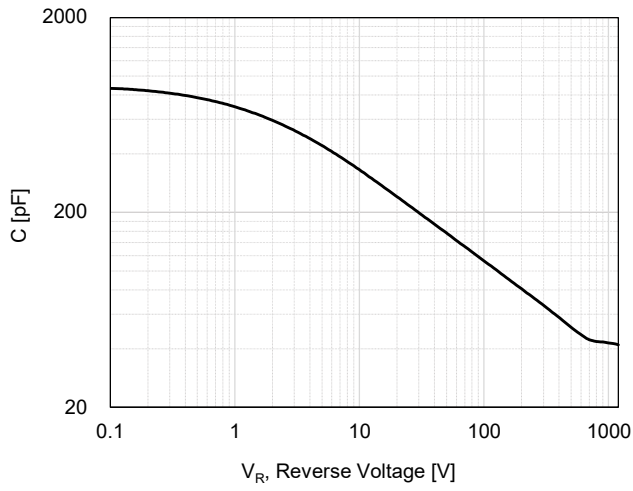
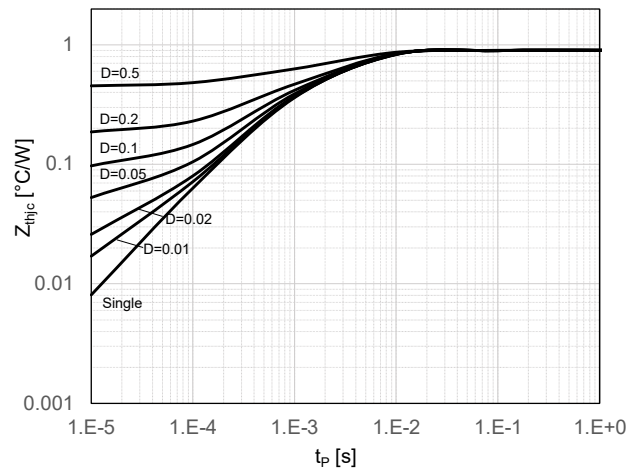
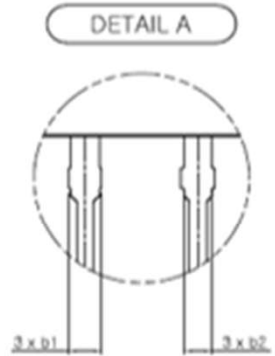
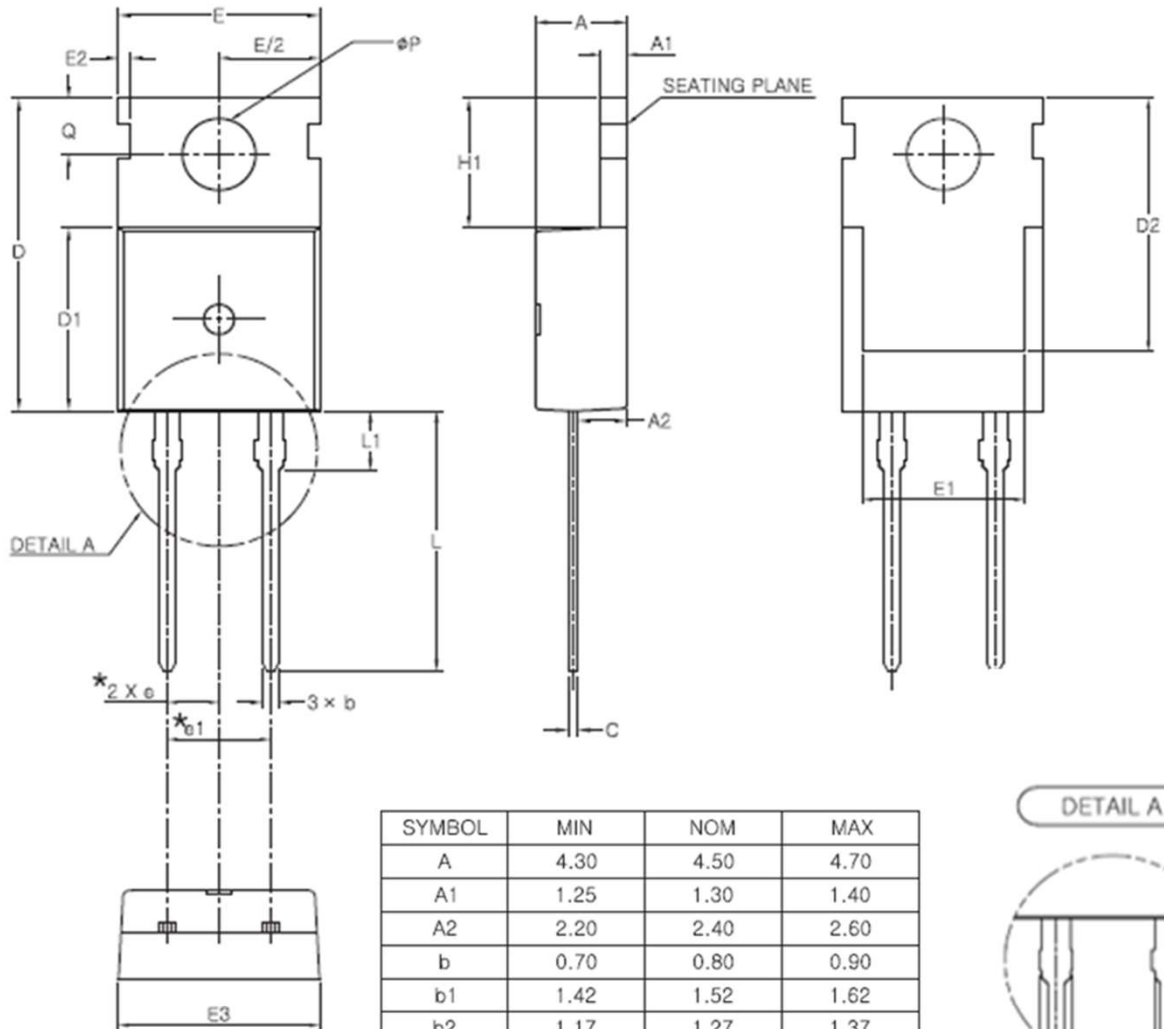

Figure 8. Transient Thermal Response Curve



Package Outlines
TO-220-2L

TO-220-2L



SYMBOL	MIN	NOM	MAX
A	4.30	4.50	4.70
A1	1.25	1.30	1.40
A2	2.20	2.40	2.60
b	0.70	0.80	0.90
b1	1.42	1.52	1.62
b2	1.17	1.27	1.37
c	0.45	0.50	0.60
D	15.50	15.70	15.90
D1	9.00	9.20	9.40
D2	(12.70)		
E	9.70	9.90	10.10
E1	(8.00)		
E2	(0.60)		
E3	9.70	9.90	10.10
e	2.54 BSC		
e1	5.08 BSC		
H1	6.30	6.50	6.70
L	12.88	13.08	13.28
L1	(3.00)		
ϕP	3.50	3.60	3.70
Q	2.70	2.80	2.90

* Dimensions in millimeters