

HCF65S06D1Q

eSiC Silicon Carbide Schottky Diode

650V, 6A

Description

The 650V eSiC is an advanced Power Master Semiconductor's silicon carbide diode family. This technology combines the benefits of excellent low capacitive charge and robustness. Consequently, the eSiC family is suitable for application requiring high power efficiency.

Applications

- Power Factor Correction
- Industrial Power Supplies
- Solar Inverter, UPS

Features

V_{RRM}	I_F	$T_{J,max}$	Q_C
650 V	6 A	175 °C	17 nC

- No reverse recovery current
- Low capacitive charge
- 175°C Max junction temperature
- High surge current capability
- Switching behavior independent of temperature
- Pb-Free, Halogen Free and RoHS compliant

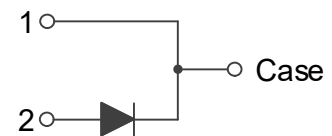
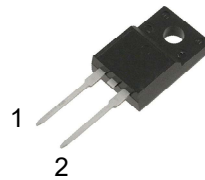

Absolute Maximum Ratings ($T_C = 25^\circ\text{C}$ unless otherwise noted)

Symbol	Parameter	Value	Unit
V_{RRM}	Repetitive Peak Reverse Voltage	650	V
I_F	Forward Current	$T_C=108^\circ\text{C}$ 6	A
$I_{F,SM}$	Non-Repetitive Forward Surge Current	$T_C=25^\circ\text{C}, t_p=10\text{ ms}$	26
		$T_C=150^\circ\text{C}, t_p=10\text{ ms}$	22.1
$I_{F,Max}$	Non-Repetitive Peak Forward Current	$T_C=25^\circ\text{C}, t_p=10\text{ us}$	290
		$T_C=150^\circ\text{C}, t_p=10\text{ us}$	247
I^2dt value	$\int i^2 dt$	$T_C=25^\circ\text{C}, t_p=10\text{ ms}$	3.3
		$T_C=150^\circ\text{C}, t_p=10\text{ ms}$	2.4
P_{tot}	Power Dissipation	$T_C=25^\circ\text{C}$ 29	W
T_J, T_{STG}	Operating Junction and Storage Temperature	-55 to +175	°C

Thermal Characteristics

Symbol	Parameter	Value	Unit
$R_{\theta JC}$	Thermal Resistance, Junction to Case, Max.	5.2	°C/W

Package Marking and Ordering Information

Part Number	Top Marking	Package	Packing Method	Quantity
HCF65S06D1Q	HCF65S06D1Q	TO-220F-2L	Tube	50 units

Electrical Characteristics (T_C = 25°C unless otherwise noted)

Symbol	Parameter	Test Conditions	Min	Typ	Max	Unit
V _F	Forward Voltage	I _F =6 A, T _C =25°C		1.50	1.8	V
		I _F =6 A, T _C =175°C		1.65	-	
I _R	Reverse Current	V _R =650 V, T _C =25°C		-	100	μA
		V _R =650 V, T _C =175°C		-	300	
Q _C	Total Capacitive Charge	V _R =400 V, T _C =25°C		17		nC
C	Total Capacitance	V _R =1 V, f=100 kHz		269		pF
		V _R =400 V, f=100 kHz		24		
E _C	Capacitance Stored Energy	V _R =400 V, T _C =25°C		2.4		μJ

Typical Performance Characteristics

Figure 1. Power Derating

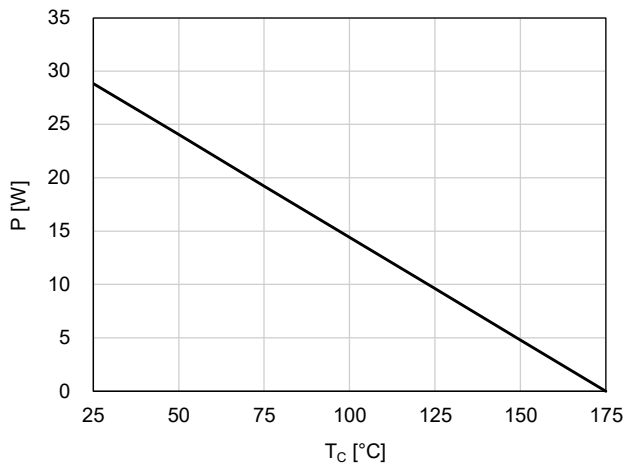

Figure 2. Current Derating

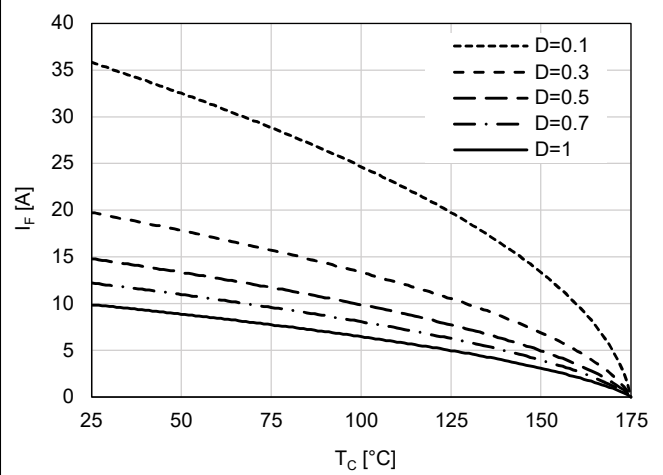

Figure 3. Forward Characteristics

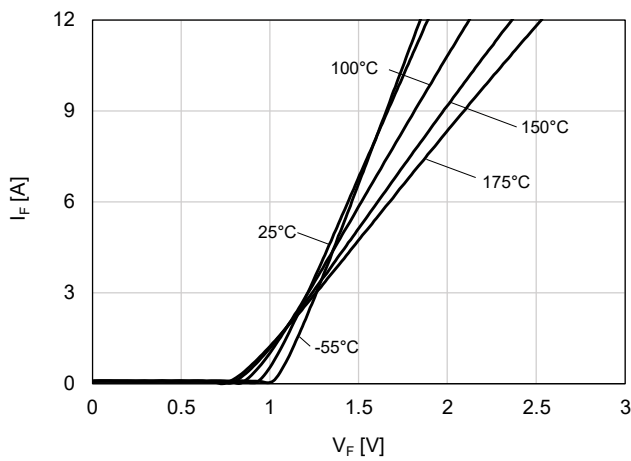

Figure 4. Reverse Characteristics

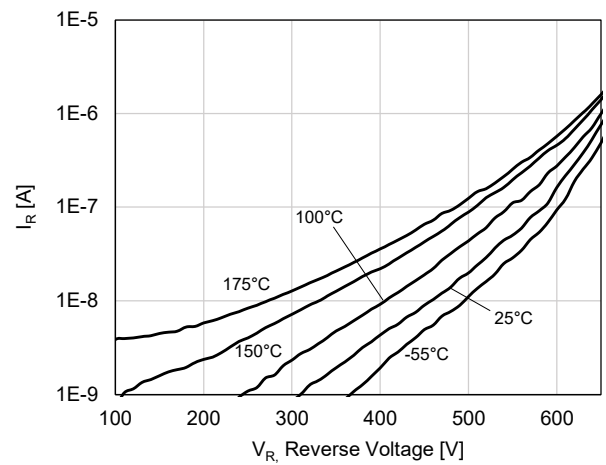

Figure 5. Capacitive Charge Characteristic

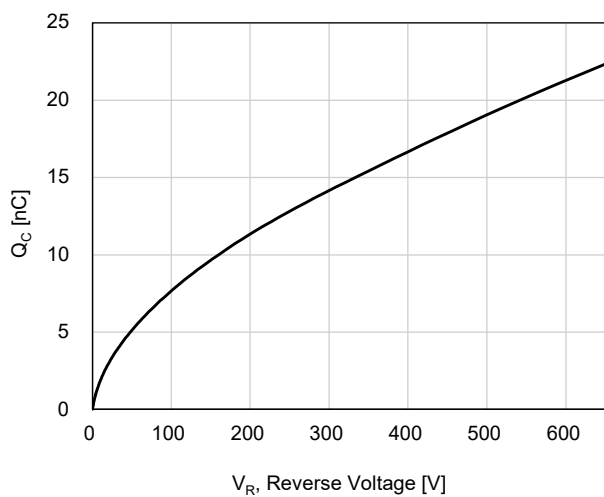
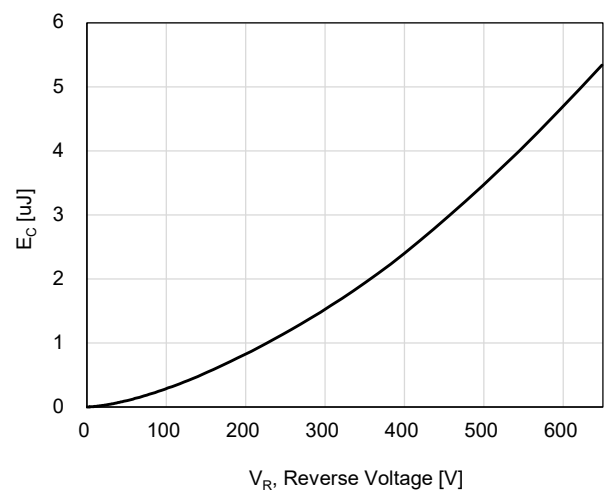

Figure 6. Capacitance Stored Energy



Typical Performance Characteristics

Figure 7. Capacitance Characteristic

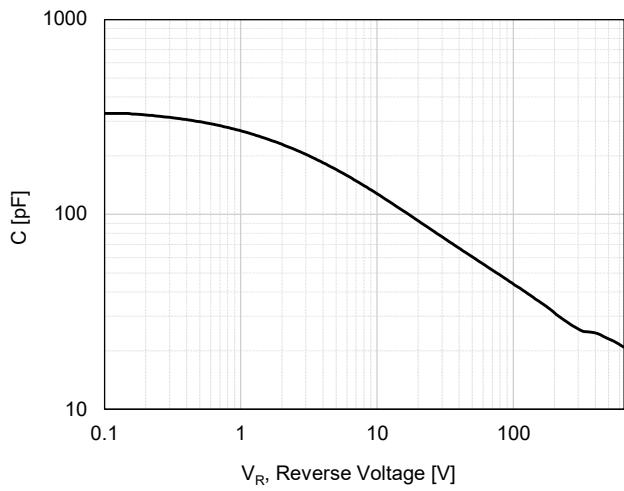
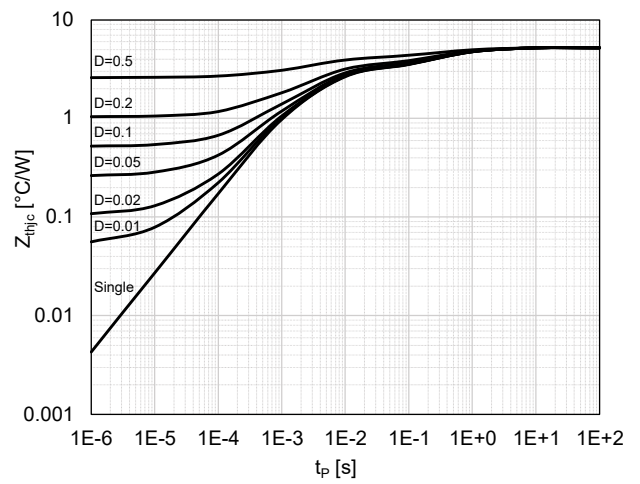
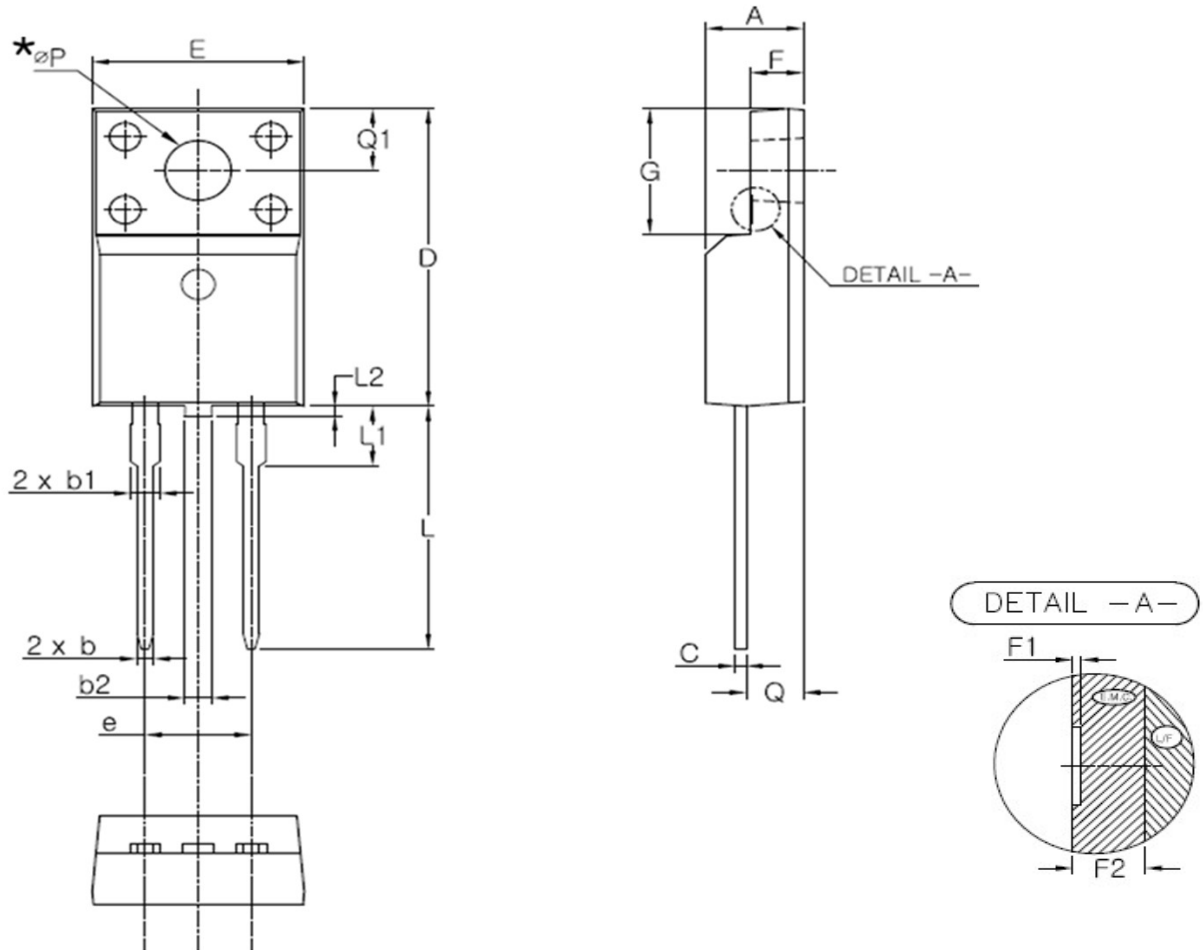

Figure 8. Transient Thermal Response Curve



Package Outlines TO-220F-2L



SYMBOL	MIN	NOM	MAX
A	4.50	4.70	4.90
b	0.70	0.80	0.90
b1	1.33	1.40	1.47
b2	0.98	1.28	1.58
C	0.45	0.50	0.60
D	15.67	15.87	16.07
E	9.96	10.16	10.36
e	5.08 BSC		
F	2.34	2.54	2.74
F1	-	-	0.50
F2	(0.74)		
G	6.48	6.68	6.88
L	12.78	12.98	13.18
L1	2.98	3.18	3.38
L2	-	-	0.80
Q	2.56	2.76	2.96
Q1	3.10	3.30	3.50
★ øP	3.08	3.18	3.28

* Dimensions in millimeters